

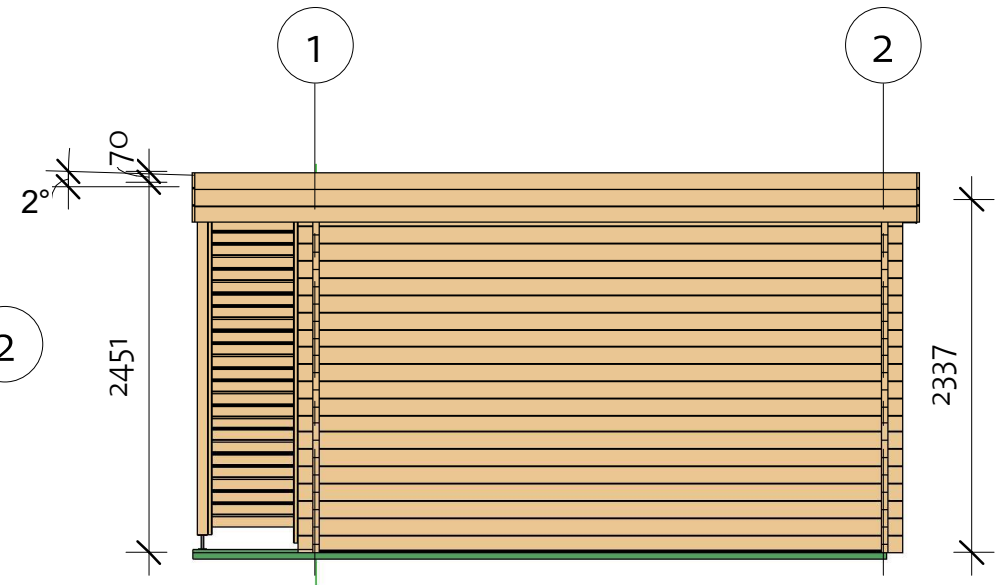

Sabrina 40 (570x380)

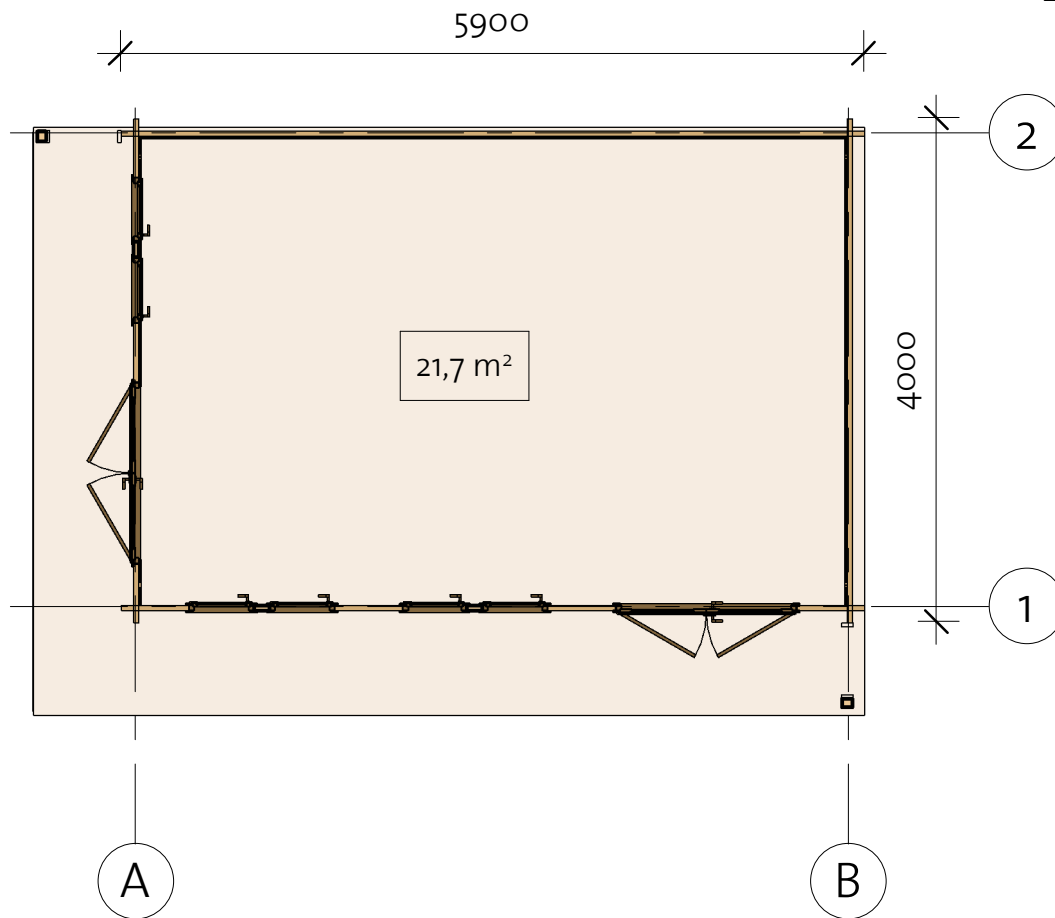
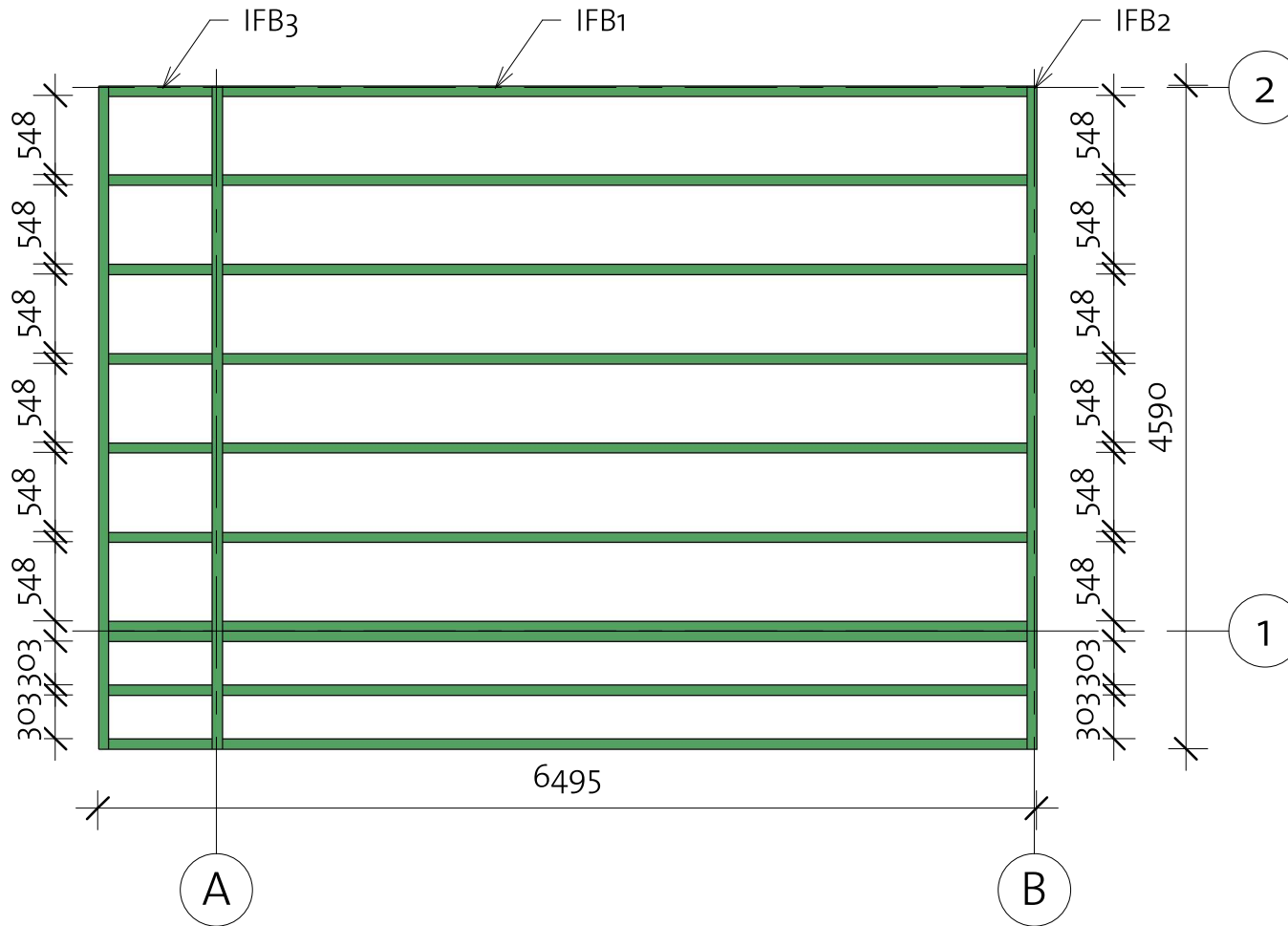

Sabrina 40 (570x380)

Foundation



Impregnated foundation beams				
Mark	Type	Profile	Count	Length
IFB1	IFB 70x40		10	5570
IFB2	IFB 70x40		3	4590
IFB3	IFB 70x40		10	715

Sabrina 40 (570x380)

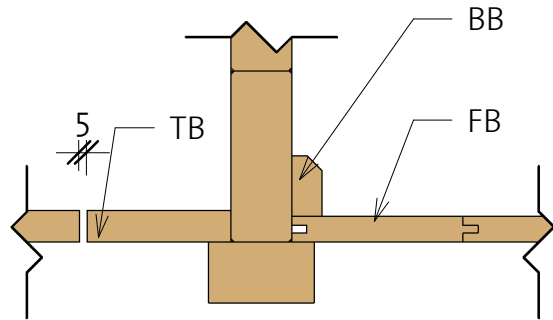

Floor Plan

① Baseboard



Floor Schedule

Mark	Type	Profile	Count	Length
------	------	---------	-------	--------

FB	FB 17x114		51	3714
TB1	TB 21x95		8	4590
TB2	TB 21x95		58	795

BB1	BB 20x40		5700	2
BB2	BB 20x40		3800	2

220421

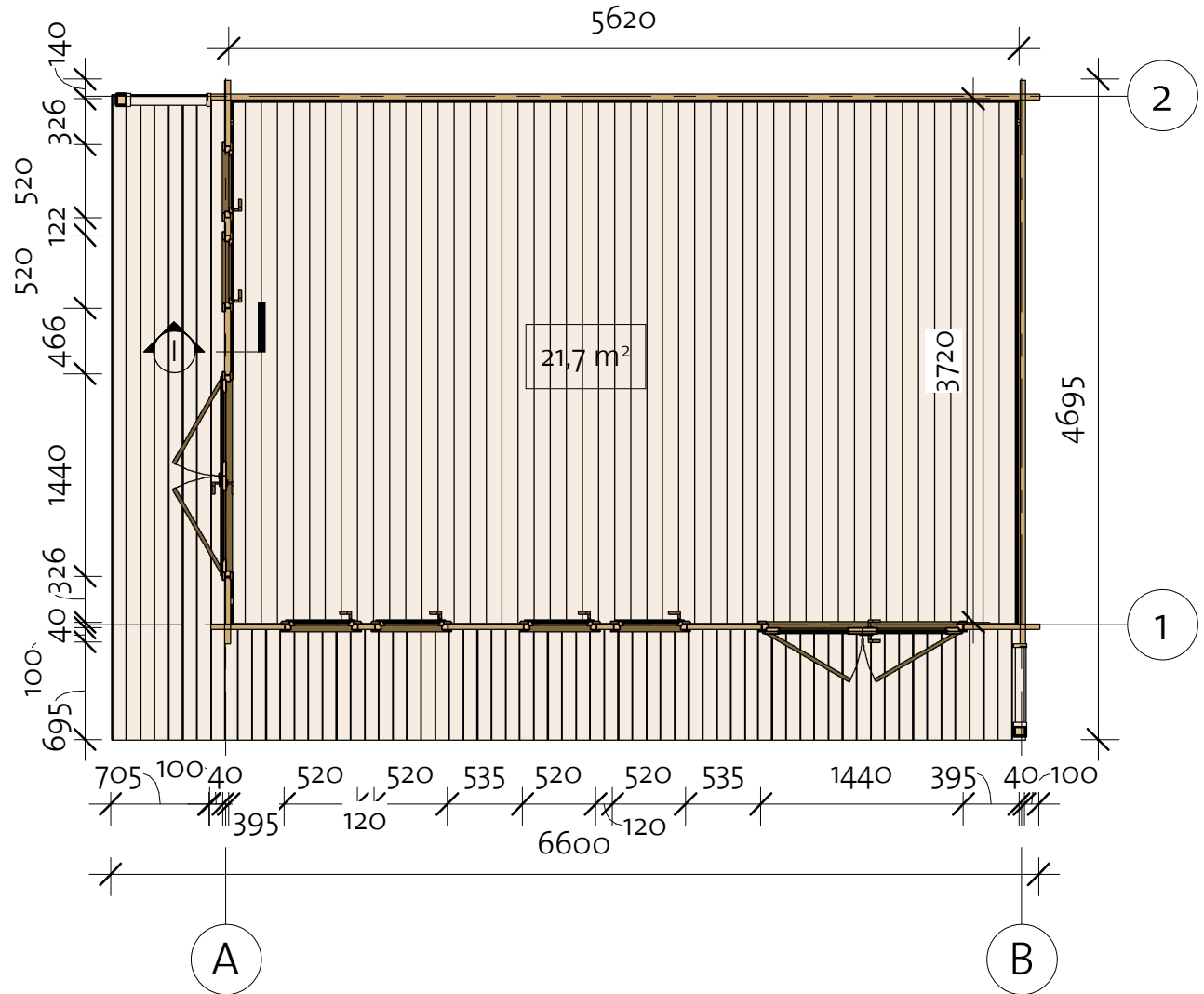

Sabrina 40 (570x380)

Wall 1

Log Profile Wall 1	
Profile	Profile

40X57	
-------	---

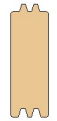
40X114	
--------	---

Log Profile Wall 1	
Profile	Profile

40X114	
--------	---

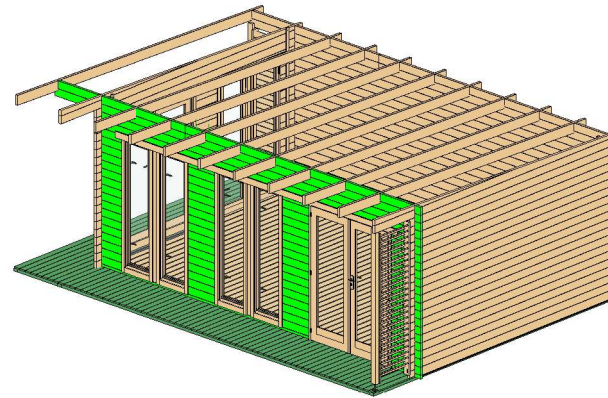

Wall 1

Mark	Profile	Count	Cut Length
------	---------	-------	------------

1BL-1	40X57	1	535
1BL-2	40X57	1	3925
1LG-1	40X114	1	5900
1LG-2	40X114	34	535
1LG-3	40X114	34	535
1LG-4	40X114	1	4250
1LG-5	40X114	1	2351
1LG-6	40X114	1	5900
1TL-1	40X114	1	4250
1TL-2	40X114	1	2333

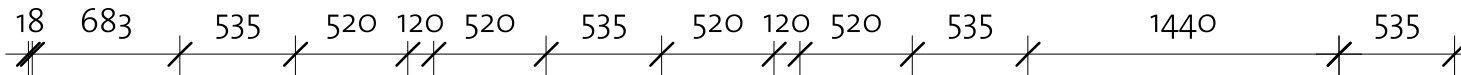
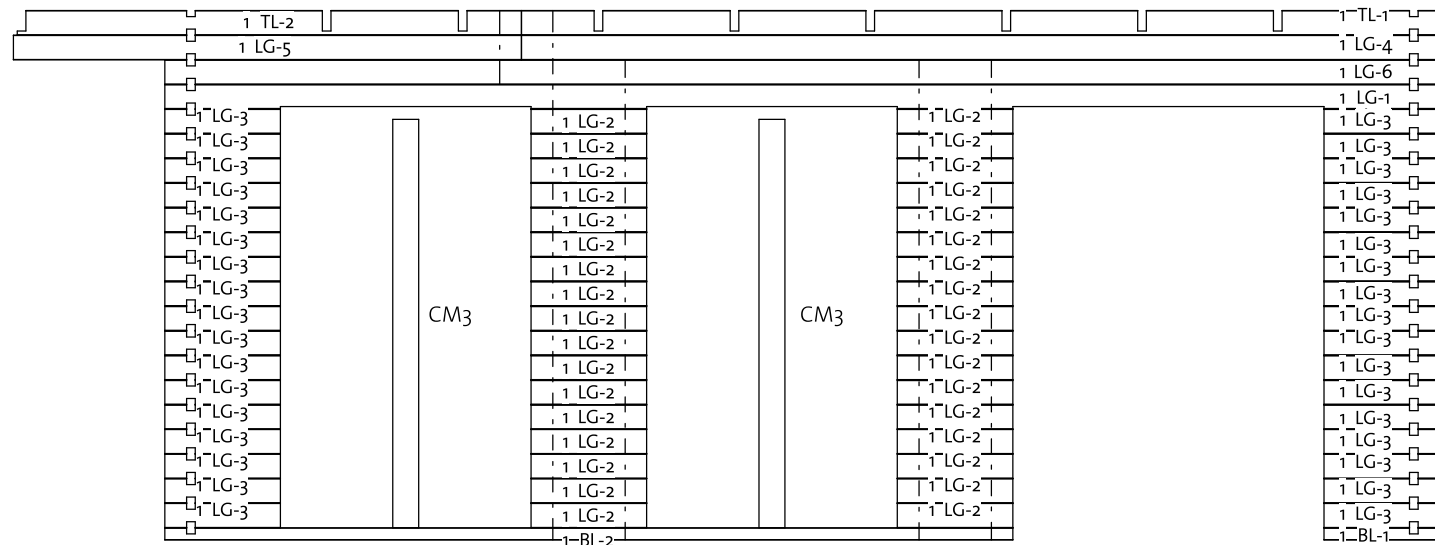

Columns Wall 1

Mark	Profile	Count	Length
------	---------	-------	--------



CM3	Post 40x120	2	1890
-----	-------------	---	------

Sabrina 40 (570x380)

Wall 2

Log Profile Wall 2	
Profile	Profile

Log Profile Wall 2	
Profile	Profile

40x57	
40x114	

40x114	
--------	---

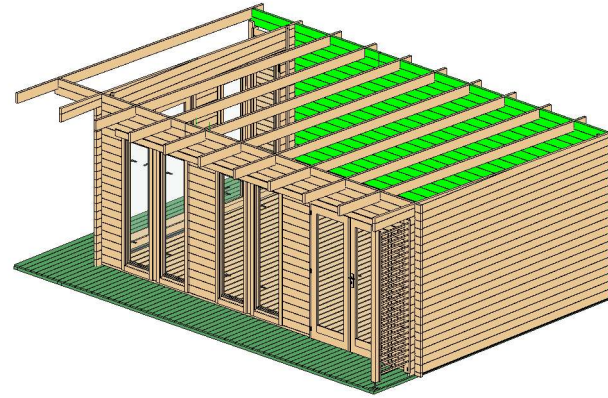

Wall 2			
Mark	Profile	Count	Cut Length

2BL-1	40x57	1	5900
2LG-1	40x114	1	2351
2LG-2	40x114	17	5900
2LG-3	40x114	1	4250
2LG-4	40x114	1	5900
2TL-1	40x114	1	4250
2TL-2	40x114	1	2333

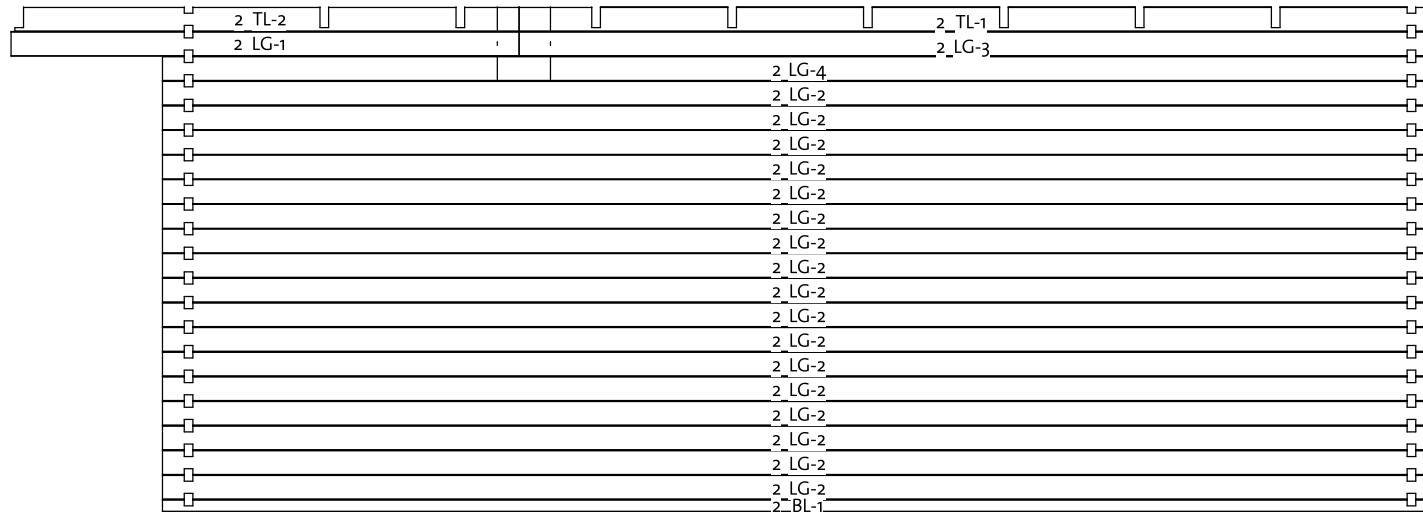

18 683

5900

Sabrina 40 (570x380)

Wall A

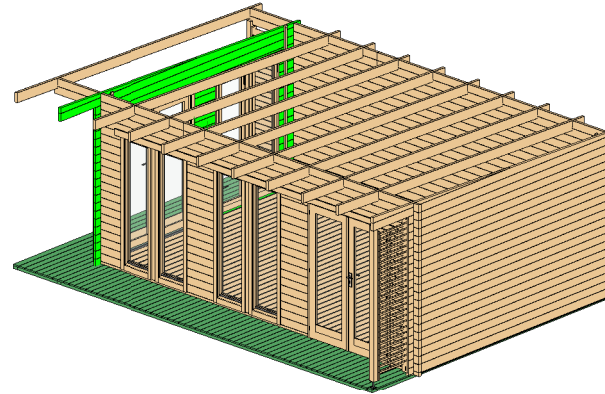

Wall A			
Mark	Profile	Count	Cut Length
ALG-1	40X114	1	4000
ALG-2	40X114	33	466
ALG-3	40X114	16	468
ALG-4*	40X114	1	2661
ALG-5	40X114	2	4000
ALG-6*	40X114	1	4681
ALG-7	40X114	1	2094

* Gable - delivered premounted

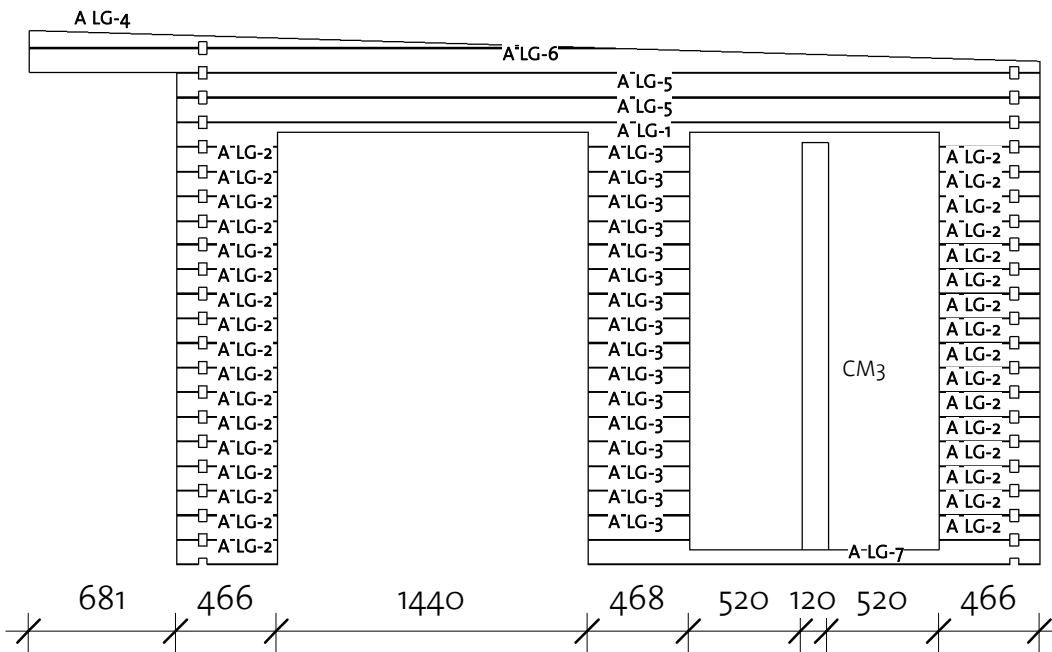

Columns Wall A			
Mark	Profile	Count	Length
CM3	Post 40x120	1	1890

Log Profile Wall A	
Profile	Profile

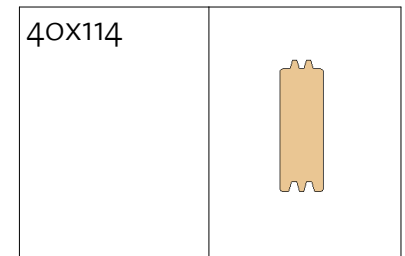

Sabrina 40 (570x380)

Wall B

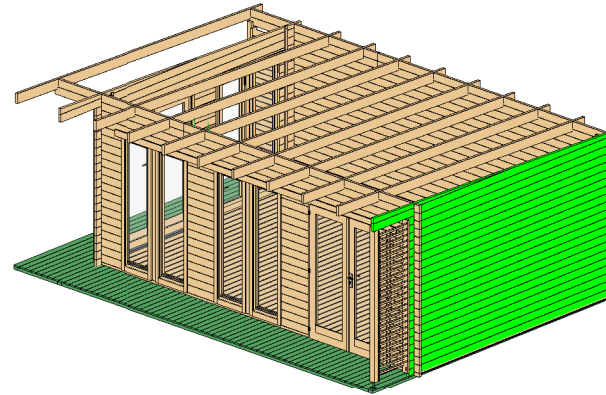

Wall B			
Mark	Profile	Count	Cut Length
BLG-1*	40X114	1	2661
BLG-2	40X114	20	4000
BLG-3*	40X114	1	4681

* Gable - delivered premounted

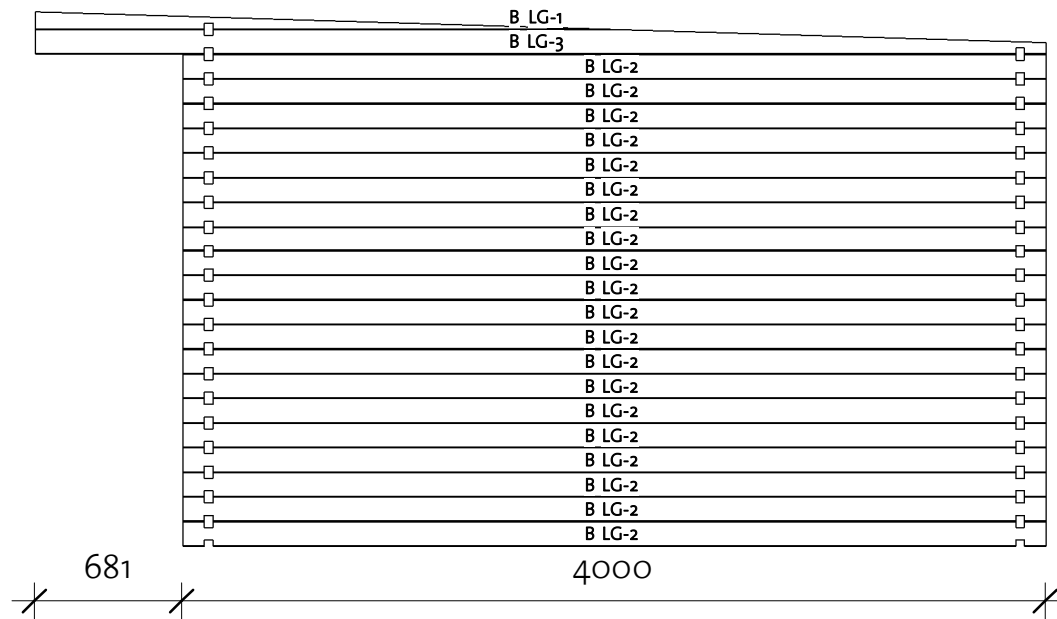

Log Profile Wall B	
Profile	Profile



40X114	
--------	---

Sabrina 40 (570x380)

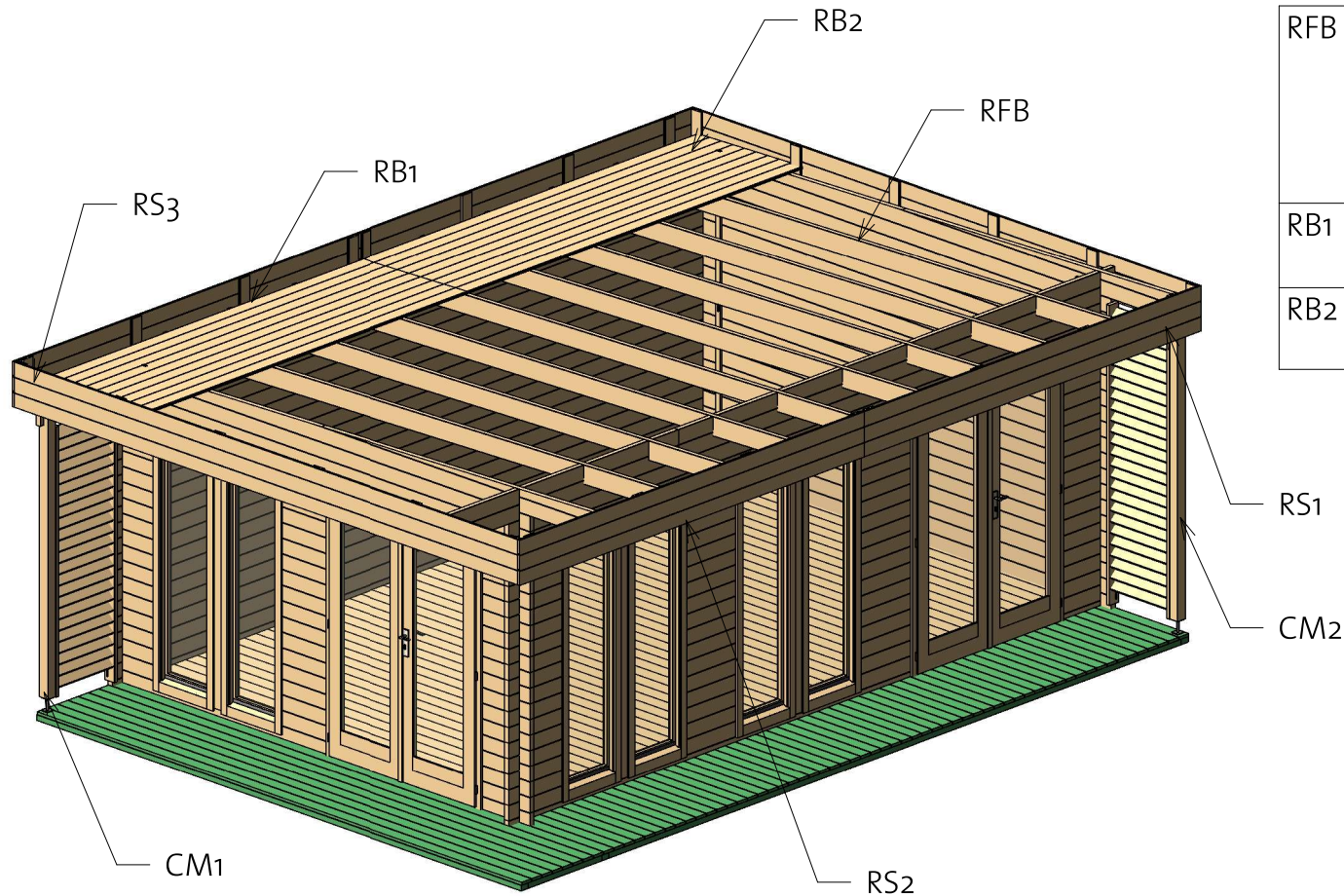
Roof 1



Roof				
Mark	Type	Profile	Count	Length

RFB	Beam 40x143		9	4779
RB1	Roofboard 17x114		42	3335
RB2	Roofboard 17x114		42	3265

Roof Side Schedule

Type	Length	Count
------	--------	-------



RS1	3282	2
RS2	3354	2
RS3	4772	2

Columns			
Mark	Profile	Count	Length

CM1	Post 80x70	1	2045
CM2	Post 80x70	1	2216

Sabrina 40 (570x380)

Roof 2

Fascia Schedule				
Mark	Type	Profile	Count	Length
EE1	Eave Edging 18x95		2	3303
EE2	Eave Edging 18x95		2	4685

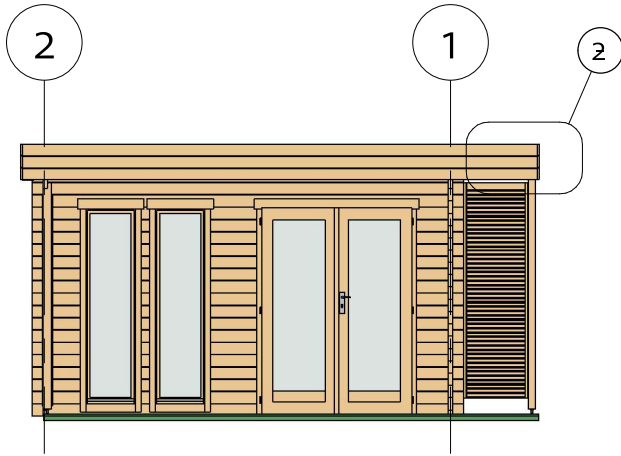

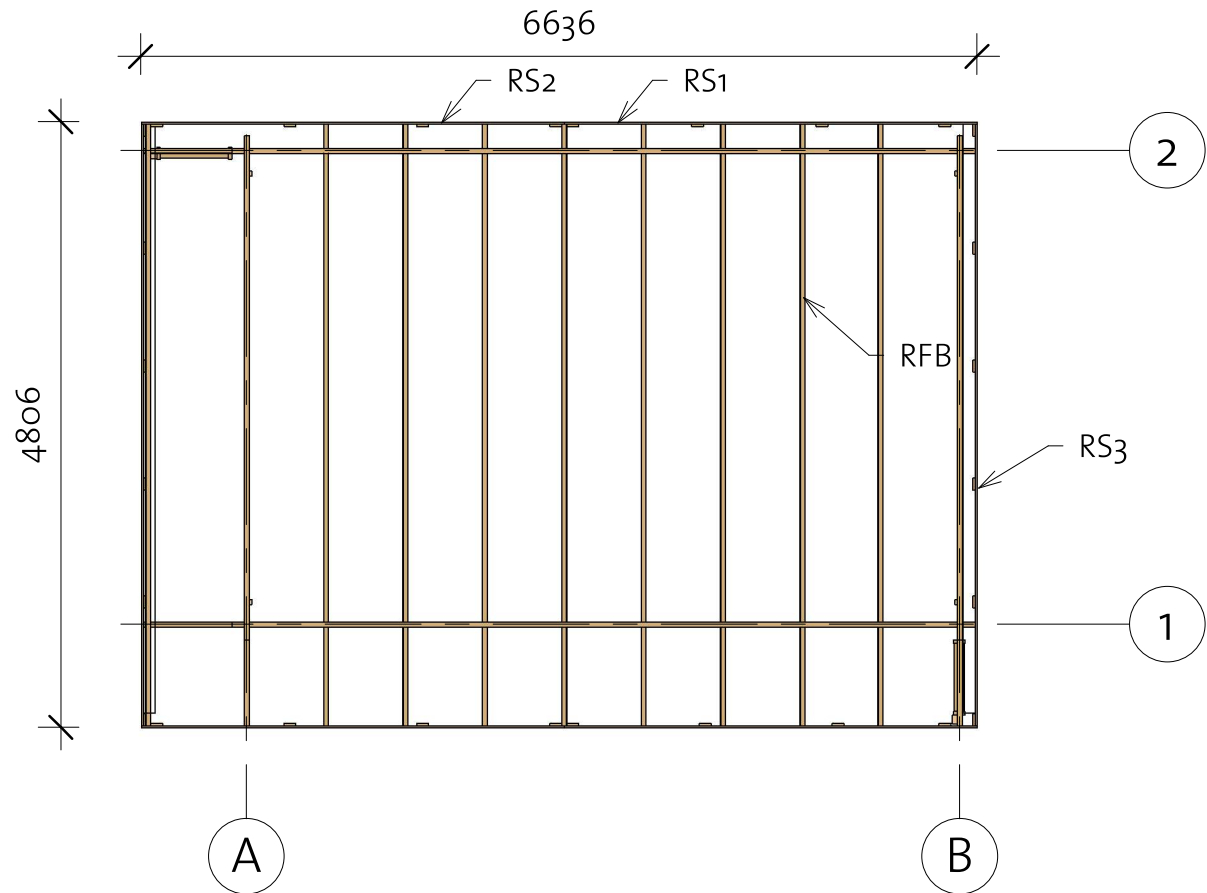
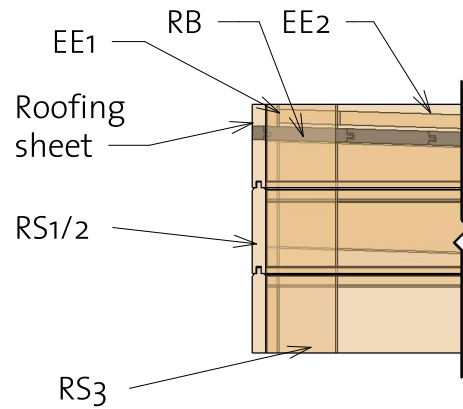

② Roof callout

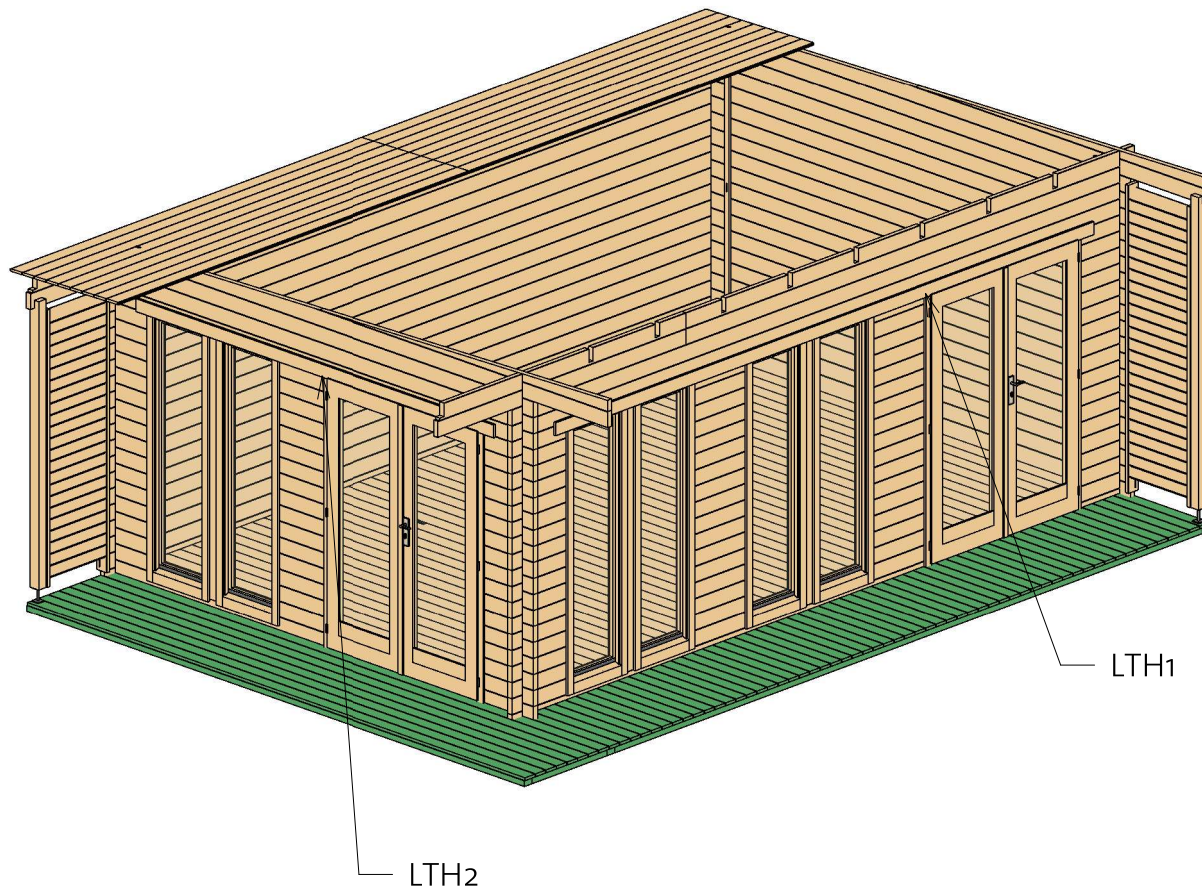

Sabrina 40 (570x380)

Roof 3



Lath list				
Mark	Type	Profile	Count	Length
LTH1	18x95		2	5100
LTH2	18x95		2	3300

Sabrina 40 (570x380)

Terrace

③ Terrace element 1

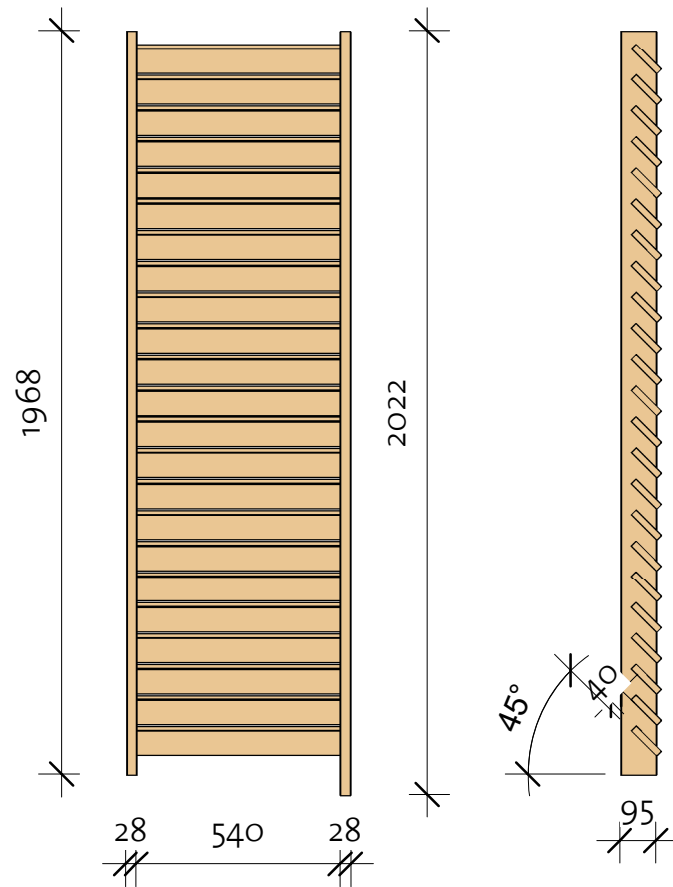

④ Terrace element 2

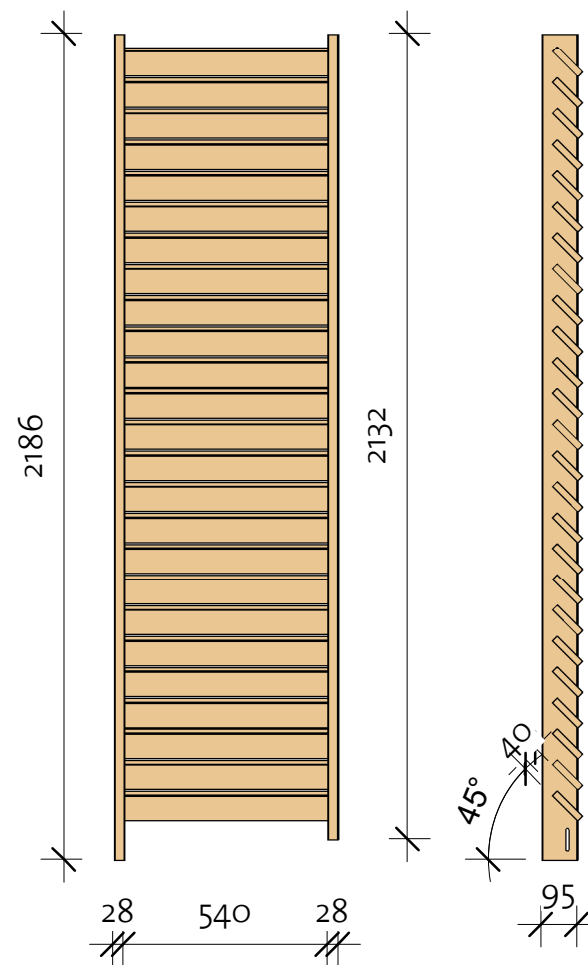

Sabrina 40 (570x380)

Extras

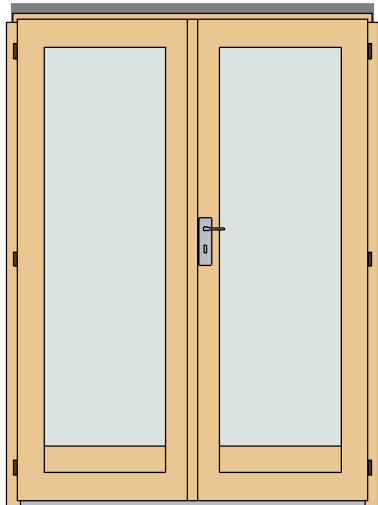

Door Schedule				
Mark	Type	Width	Height	Count
CDD3R	Classic double door 3 right	1425	1955	2
DCB8	Door Crossbar 8 optional	--	--	4
DB1	Door beam 1440 mm	40	12	2

Type	Count	Length
------	-------	--------

Windboard 18x40	4	2300
-----------------	---	------



Fasteners/Extras		
Name	Type	Count

Hitblock	300-400 mm	
Adjustable post foot		2
Screwbolt	M8x60	2
Bolts	M8 x 70	12
Screws	5,0 x 70	40
Nails	1,4 x 40	40
Dowel	16,0 x 150	75
Screws	6,0 x 140	110
Screws	4,0 x 40	1800

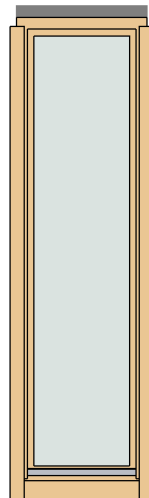

Window Schedule				
Mark	Type	Width	Height	Count

CW21R	Classic window 21 right	515	1890	6
-------	-------------------------	-----	------	---

WCB8	Windows Crossbar 8 optional	--	--	6
------	-----------------------------	----	----	---

* Windows intended for tilt opening only!



Sabrina 40 (570x380)

List of all items 1

Impregnated foundation beams

Mark	Type	Profile	Count	Length
IFB1	IFB 70x40		10	5570
IFB2	IFB 70x40		3	4590
IFB3	IFB 70x40		10	715

Roof

Mark	Type	Profile	Count	Length
RFB	Beam 40x143		9	4779
RB1	Roofboard 17x114		42	3335
RB2	Roofboard 17x114		42	3265



Columns schedule

Mark	Profile	Count	Length
CM1	Post 80x70	1	2045
CM2	Post 80x70	1	2216
CM3	Post 40x120	3	1890

Terrace schedule



Type	Count	Type	Length	Count
Terrace element 1	1	RS1	3282	2
		RS2	3354	2
Terrace element 2	1	RS3	4772	2

Floor Schedule



Mark	Type	Profile	Count	Length
FB	FB 17x114		51	3714
TB1	TB 21x95		8	4590
TB2	TB 21x95		58	795

BB1	BB 20x40		5700	2
BB2	BB 20x40		3800	2

Fascia Schedule

Mark	Type	Profile	Count	Length
EE1	Eave Edging 18x95		2	3303
EE2	Eave Edging 18x95		2	4685

Lath list

Mark	Type	Profile	Count	Length
LTH1	18x95		2	5100
LTH2	18x95		2	3300

Sabrina 40 (570x380)

List of all items 2

Wall 1			
Mark	Profile	Count	Cut Length

1BL-1	40X57	1	535
1BL-2	40X57	1	3925
1LG-1	40X114	1	5900
1LG-2	40X114	34	535
1LG-3	40X114	34	535
1LG-4	40X114	1	4250
1LG-5	40X114	1	2351
1LG-6	40X114	1	5900
1TL-1	40X114	1	4250
1TL-2	40X114	1	2333

Wall 2			
Mark	Profile	Count	Cut Length

2BL-1	40X57	1	5900
2LG-1	40X114	1	2351
2LG-2	40X114	17	5900
2LG-3	40X114	1	4250
2LG-4	40X114	1	5900
2TL-1	40X114	1	4250
2TL-2	40X114	1	2333

Wall A			
Mark	Profile	Count	Cut Length

ALG-1	40X114	1	4000
ALG-2	40X114	33	466
ALG-3	40X114	16	468
ALG-4*	40X114	1	2661
ALG-5	40X114	2	4000
ALG-6*	40X114	1	4681
ALG-7	40X114	1	2094

Wall B			
Mark	Profile	Count	Cut Length

BLG-1*	40X114	1	2661
BLG-2	40X114	20	4000
BLG-3*	40X114	1	4681

* Gable - delivered premounted

Log Profiles	
Profile	Profile

40X57	
-------	---

Log Profiles	
Profile	Profile

40X114	
40X114	